

# TN Power (LiFePO4) Data Sheet

TN-LFP12.8V84Ah Models

## GENERAL SPECIFICATIONS

ELECTRICAL SPECIFICATIONS	
<b>Nominal Voltage</b>	12.8V
<b>Nominal Capacity</b>	84Ah@0.2C
<b>Energy</b>	1075.2Wh
<b>Internal Resistance</b>	45≤mΩ
<b>Cycle Life</b>	>2000 Cycles @ 0.2C Charging/Discharging at 100%DOD, Until 70% Capacity.
<b>Self Discharge</b> ≤3.5% per month at 25°C	≤3.5% per month at 25°C
DISCHARGE SPECIFICATIONS	
<b>Discharging Current</b>	16.8A
<b>Max. Continuous Current</b>	60A
<b>Max Pulse Current</b>	120A (<3S)
<b>Discharging Cut-off Voltage</b>	10.0V
MECHANICAL SPECIFICATIONS	
<b>Cell &amp; Format</b>	IFR32700 N60, 4S14P
<b>Casing</b>	ABS
<b>Dimension(L*W*H*TH)</b>	260*169*213*218mm
<b>Weight</b>	10.2Kg (Approx)
<b>Terminal</b>	M8
<b>Group Size</b>	24
CHARGE SPECIFICATIONS	
<b>Charging Voltage</b>	14.6±0.2V
<b>Charging Mode (CC/CV)</b>	At 0°C~45°C temperature, charged to 14.6V at a constant current of 0.2C5A, and then, charged continuously with constant voltage of 14.6V until the current is no more than 0.02C5A.
<b>Charging Current</b>	16.8A
<b>Max Charging Current</b>	42A
TEMPERATURE SPECIFICATIONS	
<b>Charge Temperature</b>	0°C to 45°C (32°F to 113°F) @60±25% Relative Humidity
<b>Discharge Temperature</b>	-20°C to 60°C (-4°F to 140°F) @60±25% Relative Humidity
<b>Storage Temperature</b>	0°C to 45°C (32°F to 113°F) @60±25% Relative Humidity
<b>Water Dust Resistance</b>	IP55



## FEATURES

- Using the technology of lithium iron phosphate cell, it offers superior safety, and the most stable components.
- 2000 lifecycles @ 100%DOD, under normal conditions.
- Built-in automatic protection for over-charge, over discharge, over current and over temperature.
- Maintenance Free.
- Internal cell balancing.
- About 40% ~50% of the weight of a comparable lead acid battery.
- Wider temperature range: -20°C ~60°C.
- Support for Series application expansion (up to 51.2V) and two in parallel.
- Lower overall total cost of ownership.

## APPLICATION

- Recreational Vehicles
- Marine
- Renewable Energy
- Medical / Mobility
- Electric Vehicles
- Golf Cart

## DIMENSIONAL SPECIFICATIONS

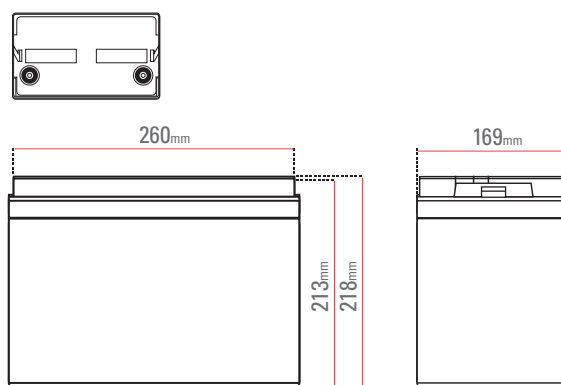

# Lithium Iron Phosphate (LiFePO4) Battery | MODEL: TN-LFP12.8V84AH

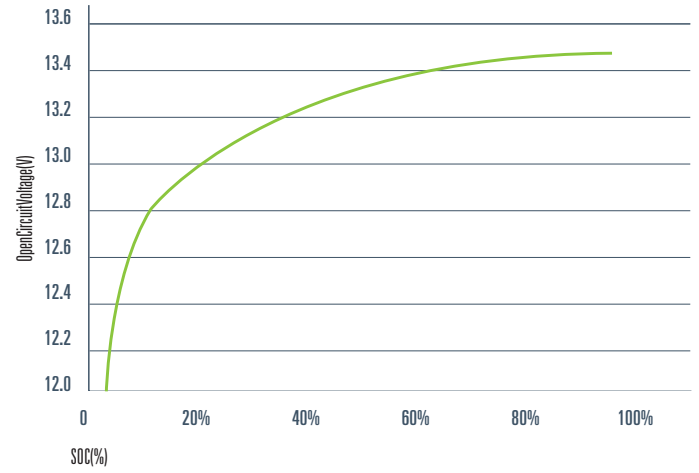
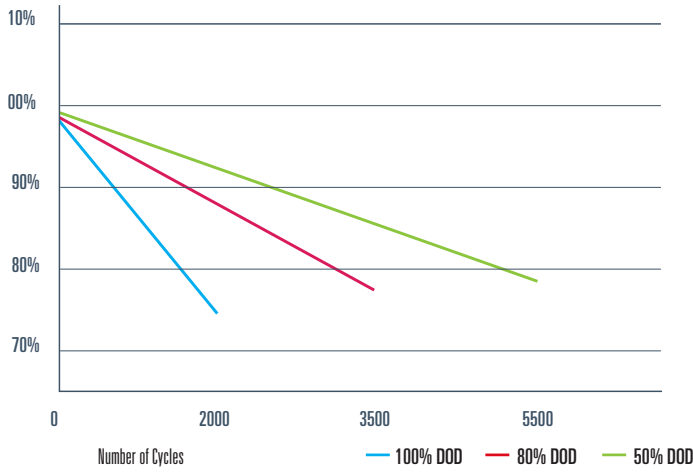
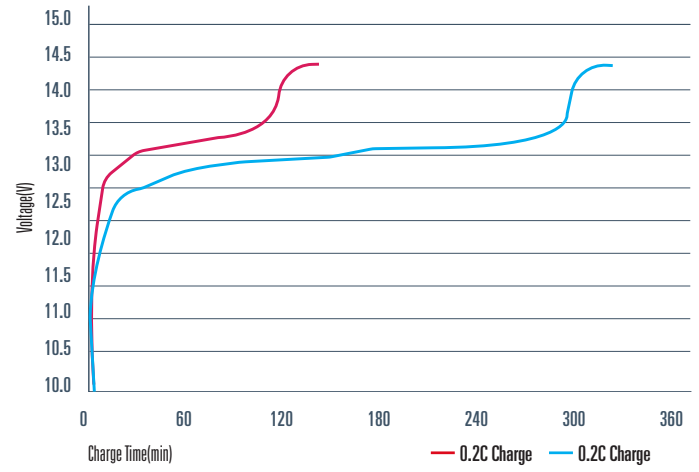
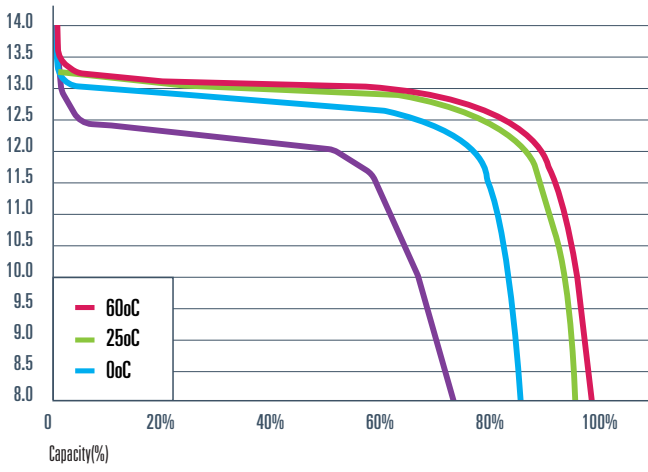
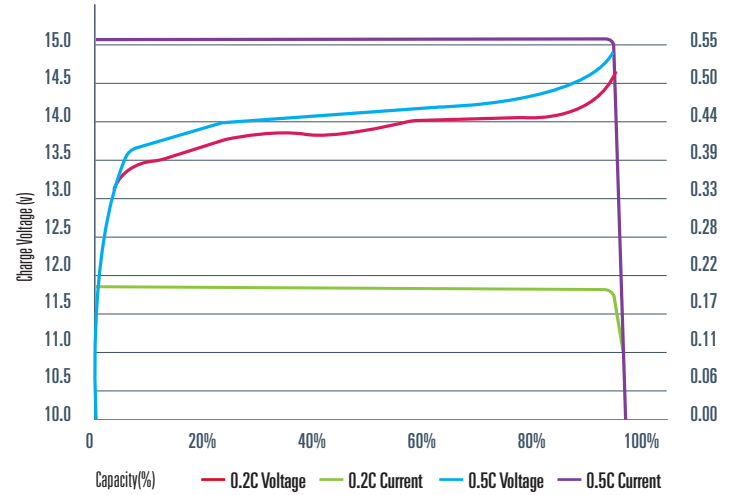
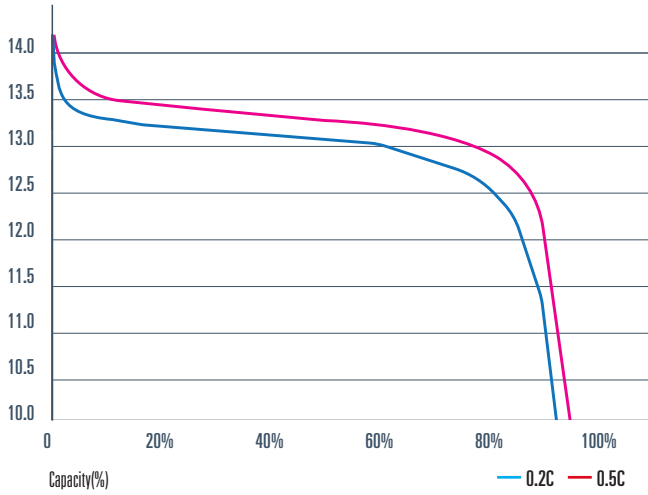

TN POWER Lithium is UN38.3 certified

